

TILSATSPROFIL  
TIL EMALITGLAS

Profil 3194  
Vægt = 0,272kg/m

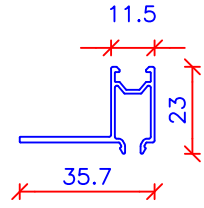

TILSATSPROFIL  
TIL EMALITGLAS

Profil 3108  
Vægt = 0,328kg/m

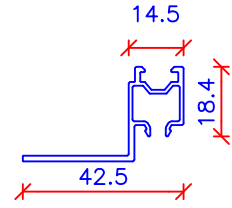

KASSETTECLIPS

Profil 3134  
Vægt = 0,332kg/m

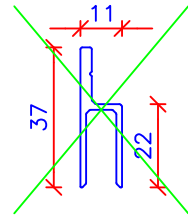

F-LISTE

Profil 3107  
Vægt = 0,285kg/m

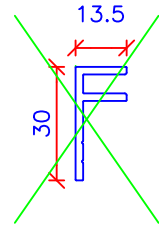

L-PROFIL

Profil 3212  
Vægt = 1,214kg/m

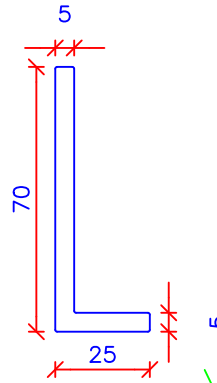

CLIPSSPROFIL

Profil 3223  
Vægt = 1,133kg/m

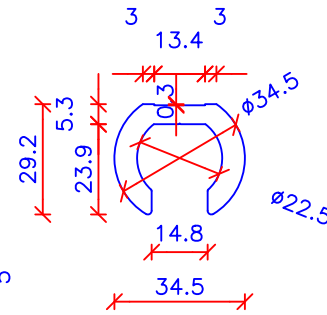

UDFYLDINGSPROFIL

Profil 3224  
Vægt = 0,173kg/m

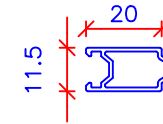

TILSÆTNING

Profil 3240  
Vægt = 0,486kg/m

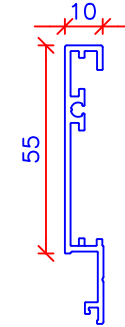

SPECIALPROFIL

Profil 3136  
Vægt = 1,464kg/m

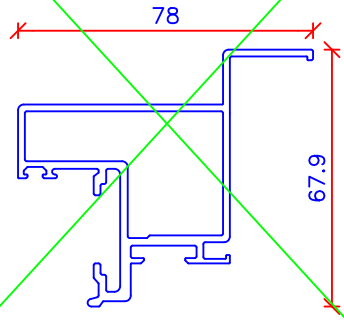

Profil 3140  
Vægt = 1,164kg/m

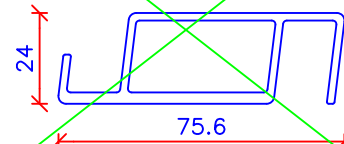

Profil 3160  
Vægt = 1,643kg/m

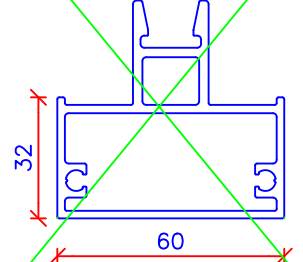

Profil 3161  
Vægt = 1,409kg/m

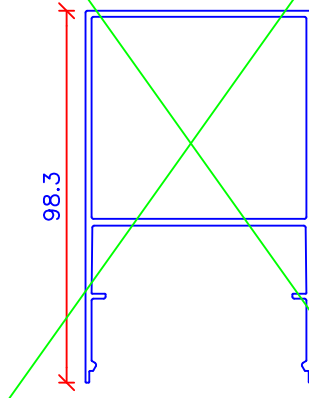

Profil 3162  
Vægt = 3,314kg/m

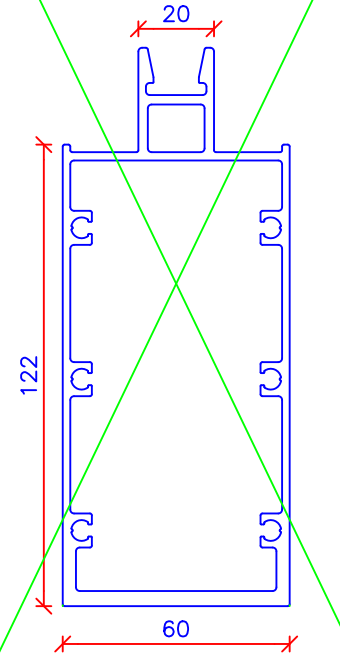

Profil 3163  
Vægt = 0,949kg/m

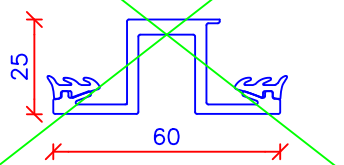

Profil 3172  
Vægt = 2,556kg/m

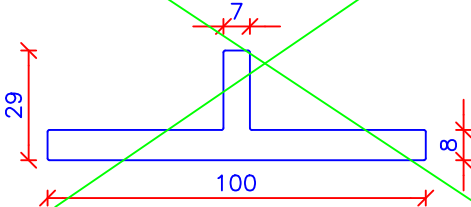

Profil 3225  
Vægt = 2,321kg/m

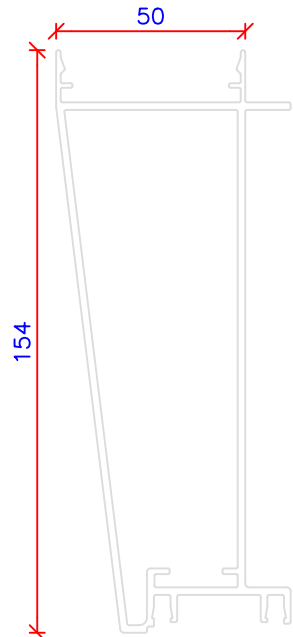

Profil 3226  
Vægt = 0,774kg/m

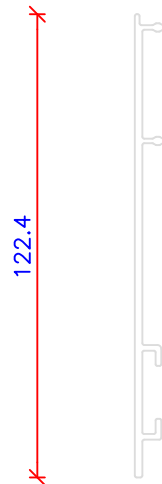

Profil 3247  
Ix = 411882  
Vægt = 3,613kg/m

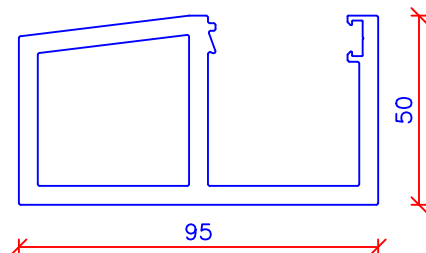

Profil 3238  
Ix = 3571 mm4  
Vægt = 0,529kg/m

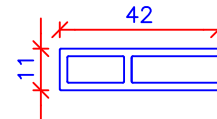

TILSÆTNINGER

Profil 3165  
Vægt = 1,112kg/m

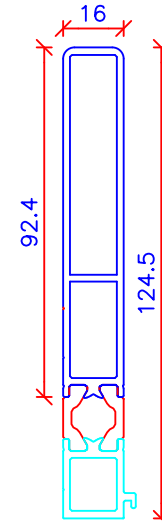

Profil 3164  
Vægt = 1,355kg/m

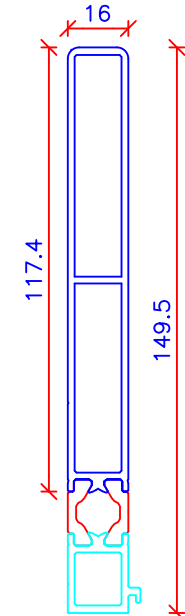

Profil 3183  
Vægt = 2,125kg/m

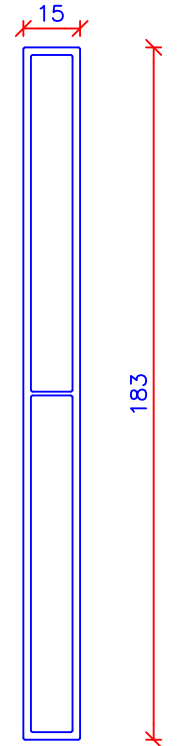

Profil 3166  
Vægt = 0,391kg/m

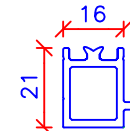

SAG: EILER THOMSEN ALUFACADER		
EMNE: PROFILOVERSIGT SPECIAL-PROFILER		
MÅL: 1:2	ORDRE NR.:	TEGN.NR.:
MÅL I MM	-	5
DATO: 24.11.14	SIGN: CA	
EILER THOMSEN ALUFACADER		
VAR LUNGAARDS VEJ 25 . 7500 HOLSTEBRO . TLF.97 41 41 88 . FAX 97 40 22 80		

